

Instruction Manual Manuel d'instruction

MP-J60-SUPP-JIG 483354

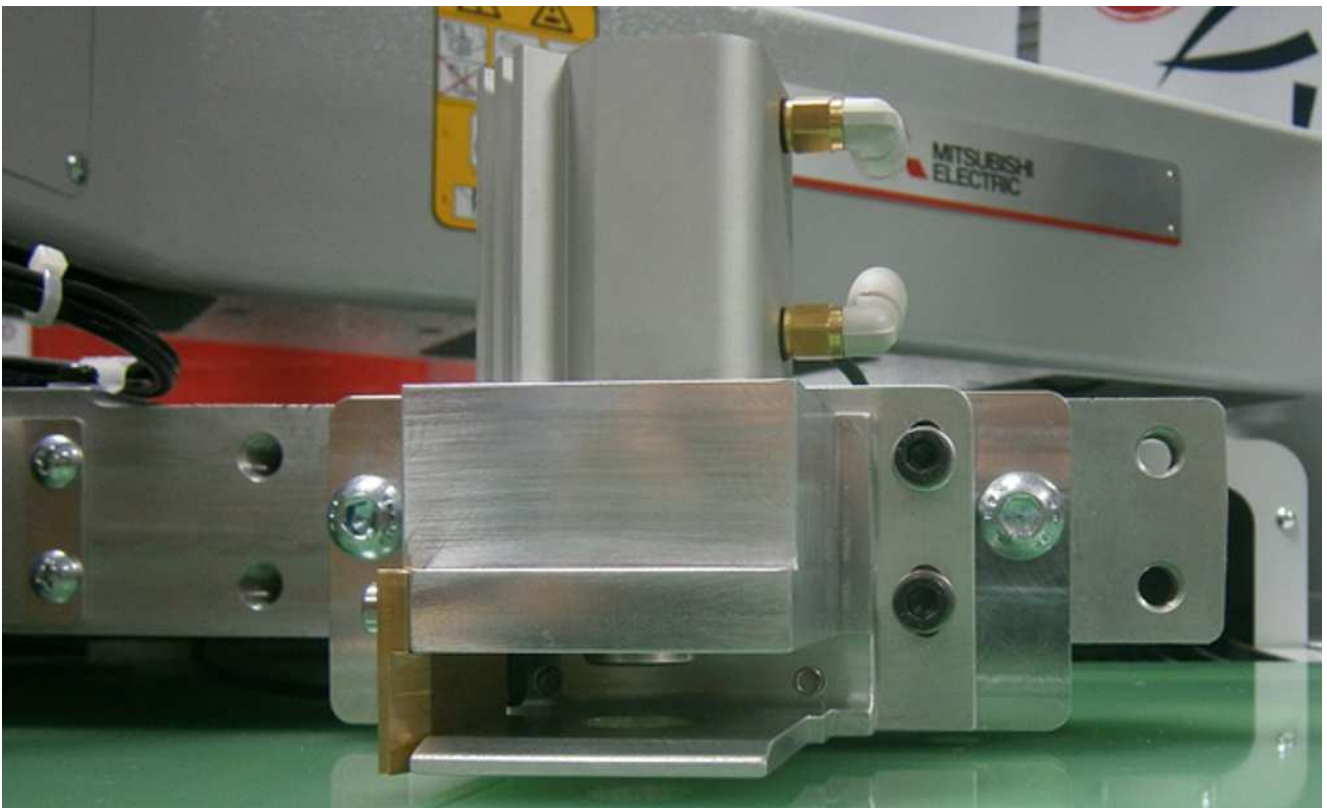

MP-J60-SUPP-JIG 483354

Version 10-2019

INSTALLATION



Fixer la plaque avec les vis M8

Fix the plate with M8 screws .

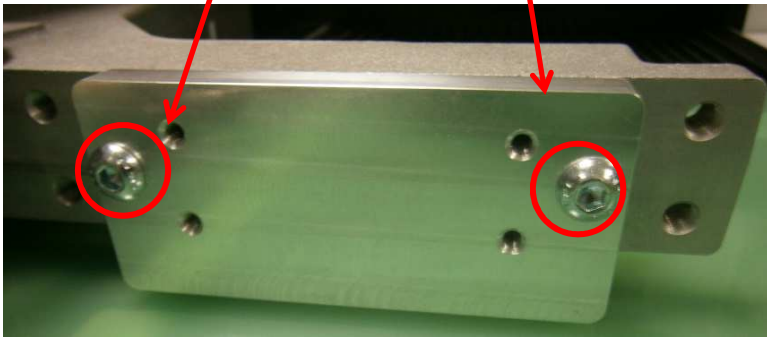

Fixer le bloc d'accrochage avec les 4 vis M4 et leurs rondelles

Fix the jig bloc with M4 screws and washers

Répéter l'opération sur le coté gauche.
Repeat this operation on the left side

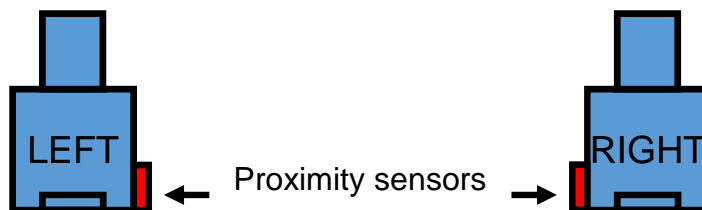

CONNECTION - CONNEXION

Original connection – Connexion originale

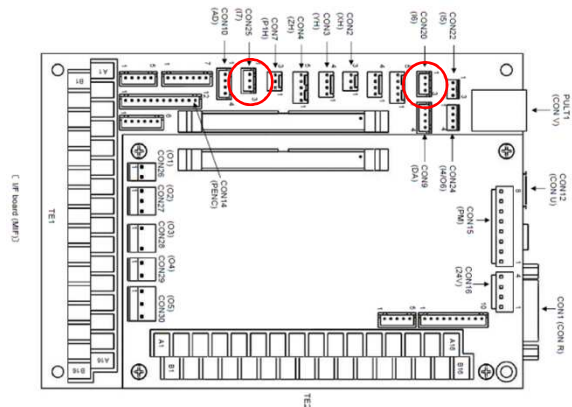
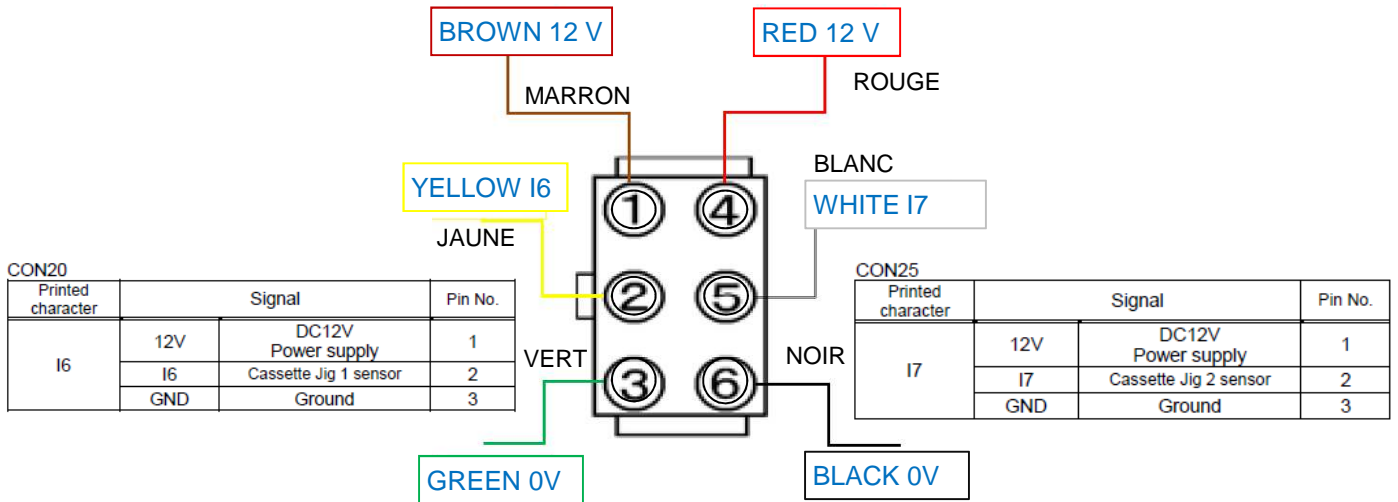

Connection of sensors – connexion des capteurs

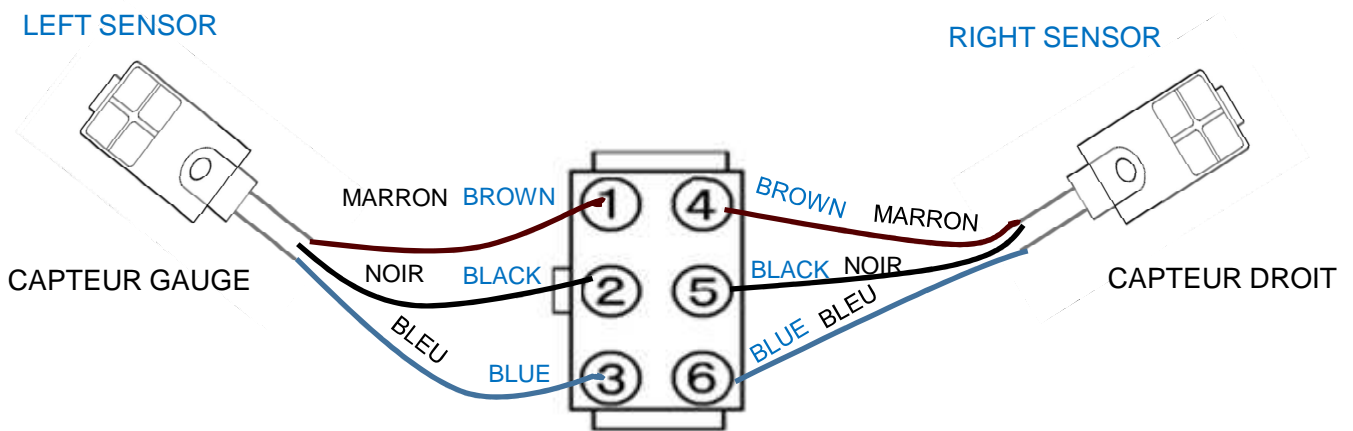

SETTING



Press MENU

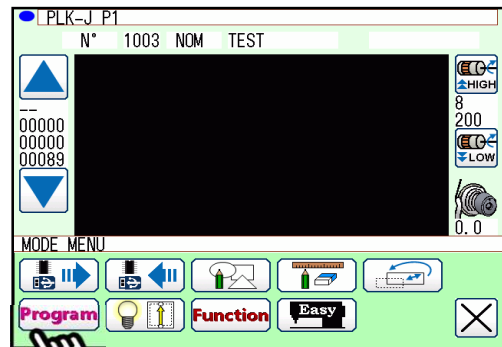

Press PROGRAM

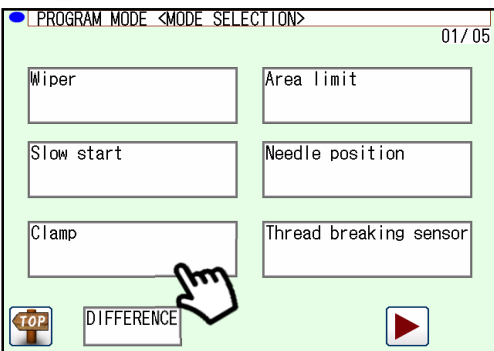

Press CLAMP

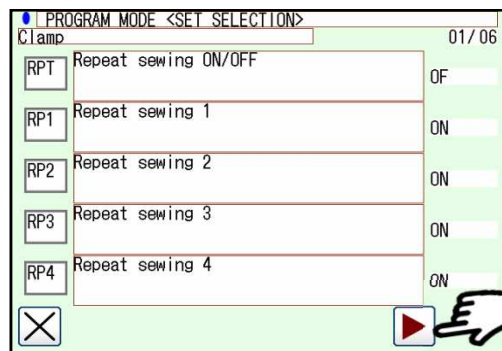

Turn pages until the last (6/6)

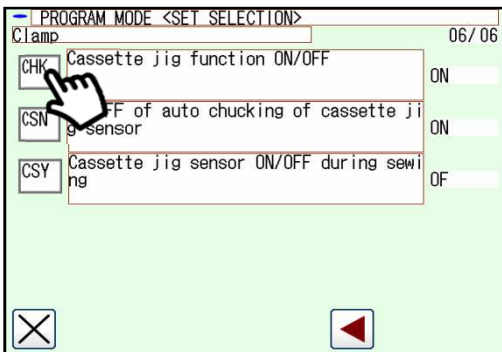

Press CHK

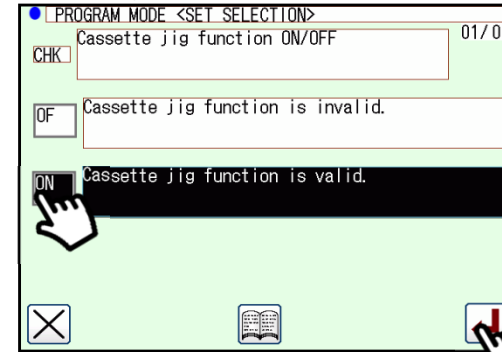

Press ON then Enter

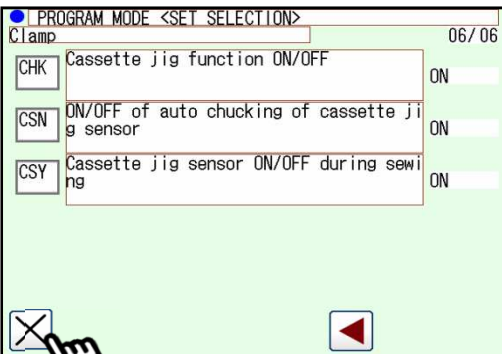

Press X

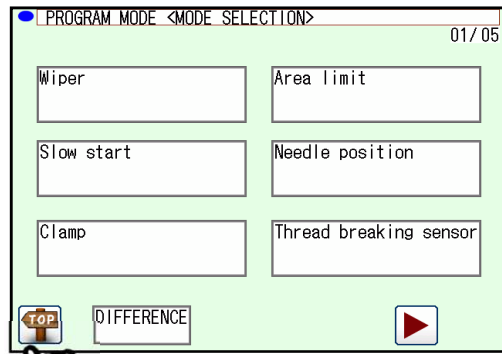

Press TOP

PARAMETRAGE



Appuyer sur MENU

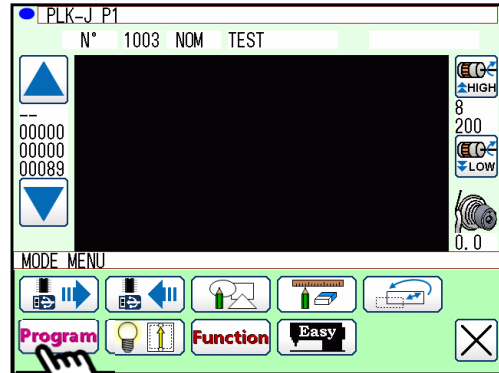

Appuyer sur PROGRAM

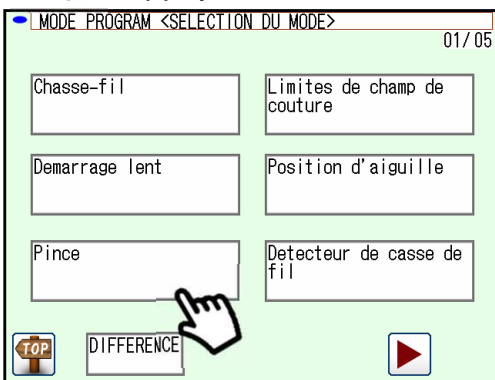

Appuyer sur PINCE



Tourner les pages jusqu'à la dernière

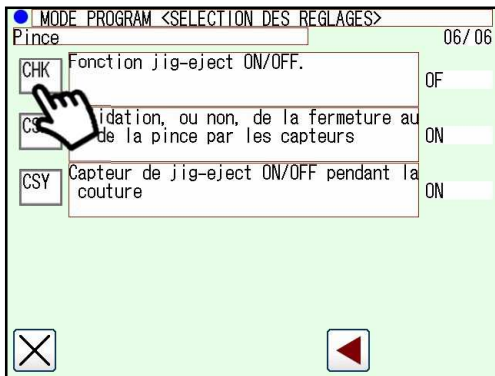

Appuyer sur CHK

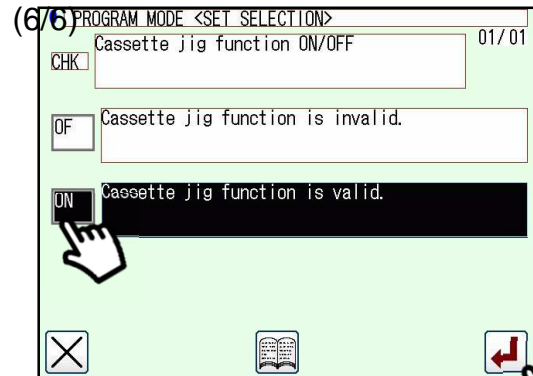

Appuyer sur ON puis sur ENTRER

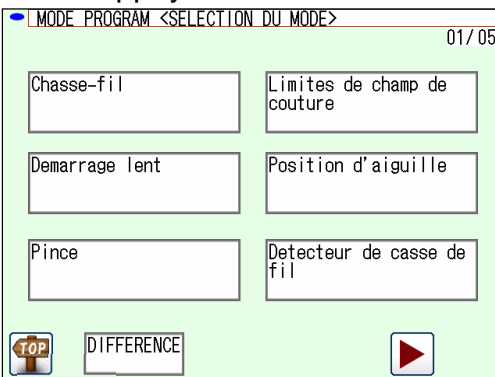

Appuyer sur X

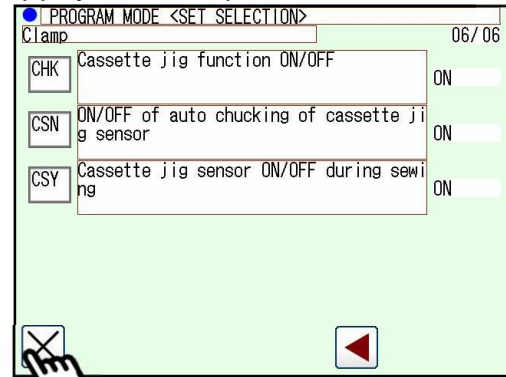

Appuyer sur TOP

IMPLANTATION

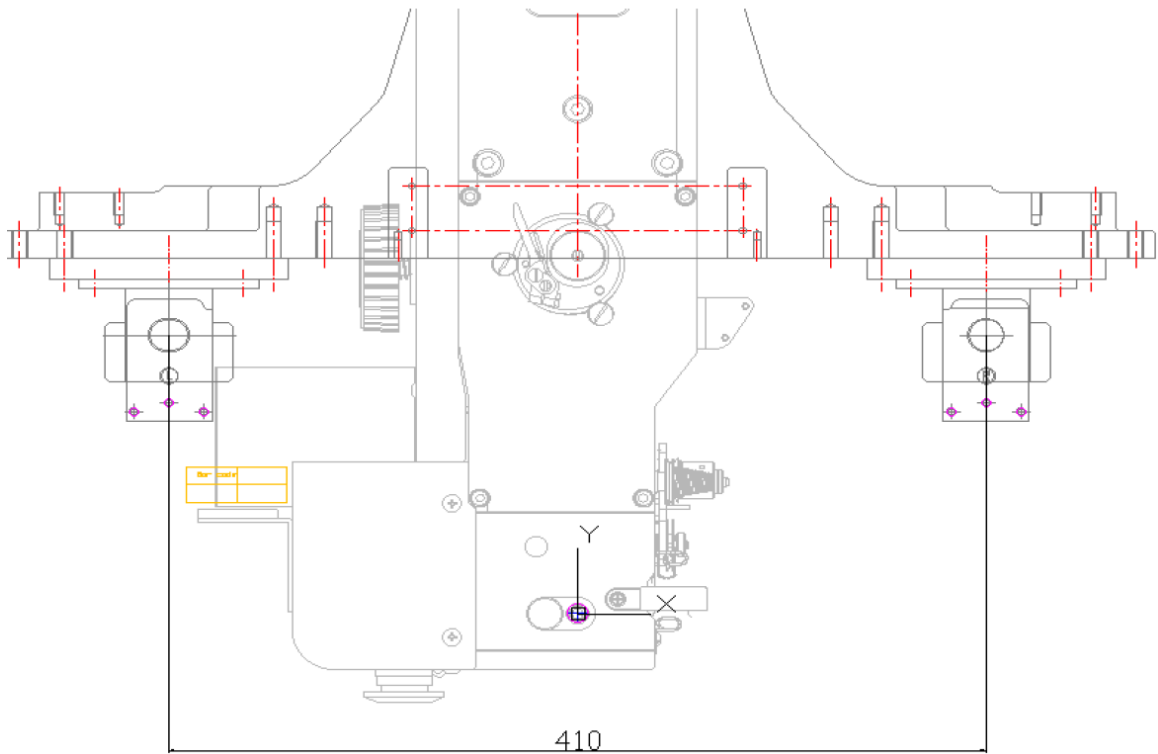

SPARE PARTS - PIECES DETACHEES

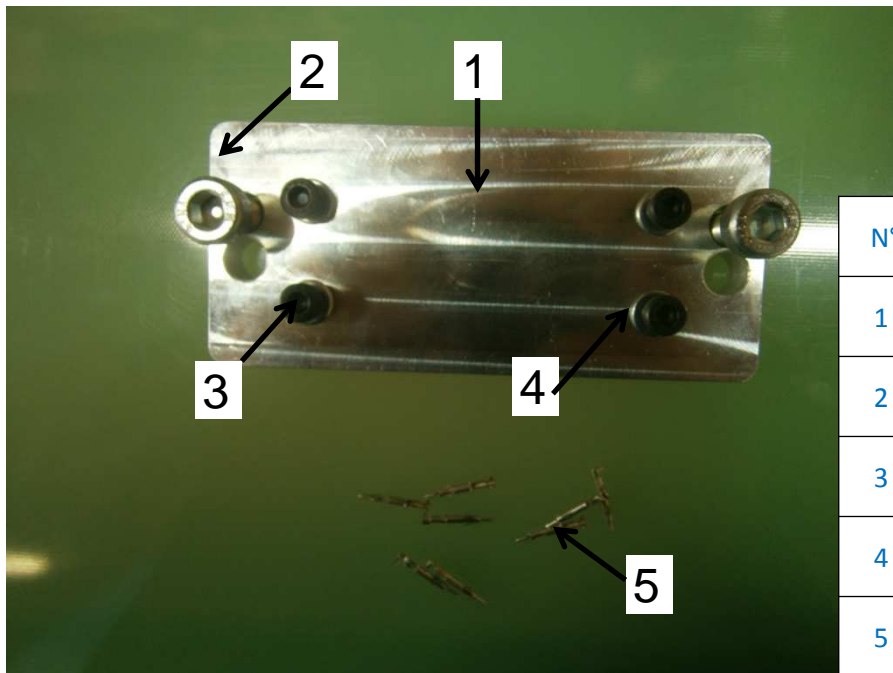

N°	NAME	Qty
1	BRACKET PLATE 410564	2
2	SCREW M8X20 297730	4
3	SCREW M5X10 194871	8
4	Washer D5 297732	8
5	PIN MJ60A0529	8



29 Bd des Bouvets 92741 Nanterre Cedex
Tel 01 41 02 83 00 - Fax 01 49 01 07 28
www.ism.mitsubishielectric.fr