

MP-G25-QUICK CHANGE

274635

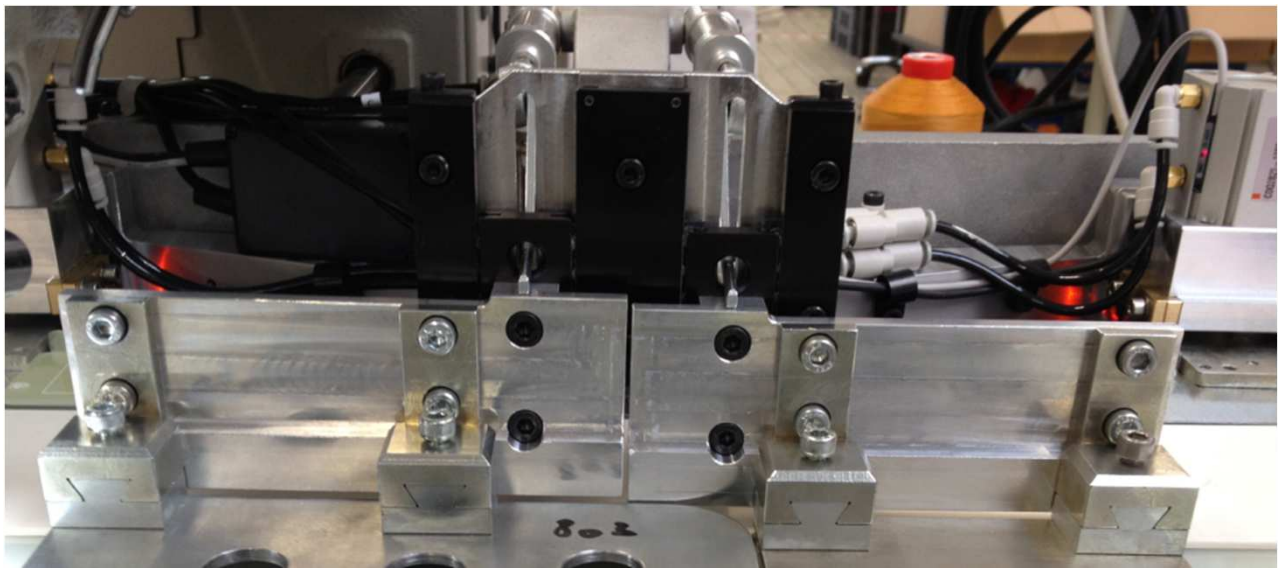

PRESENTATION

► *Ce Kit permet de séparer les pinces supérieures et de les changer rapidement avec un positionnement précis.*

Cet attachement se compose de:

- *2 supports (gauche et droit)*
- *4 Blocs femelles de réception outils*
- *4 Blocs outils mâles*
- *1 électrovanne*
- *visserie*
- *accessoires électriques et pneumatiques*

Qté	Désignation	Réf
1	Paire de supports	266511
4	Blocs de fixations femelles	243826
4	Blocs outils	243825
16	vis btr m3x6	266027
16	rondelles m3	
12	vis btr m5 long 10	194871
8	rondelles grower d5	255833
2	Raccord coudé d4	208550
4	Limiteurs de débit d4	208107
2	mètres de tuyaux pneumatique	244599
1	clé 6 pans 4 mm	7691704
6	"zip"	165825
1	Electrovanne	161354
1	joint	135986
2	Vis	161752
1	VJ10-20-4A-30 connecteur	161355
2	RS-236-3230 PIN MALE MOLEX	239460

MONTAGE

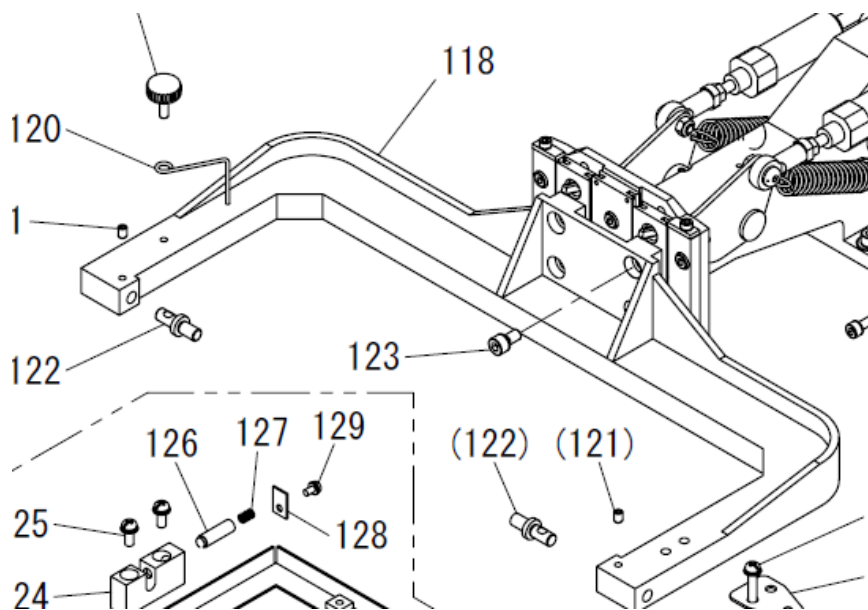

- *Enlever le support de pince n° 118 et le remplacer par le support gauche et droit avec les vis 123.*

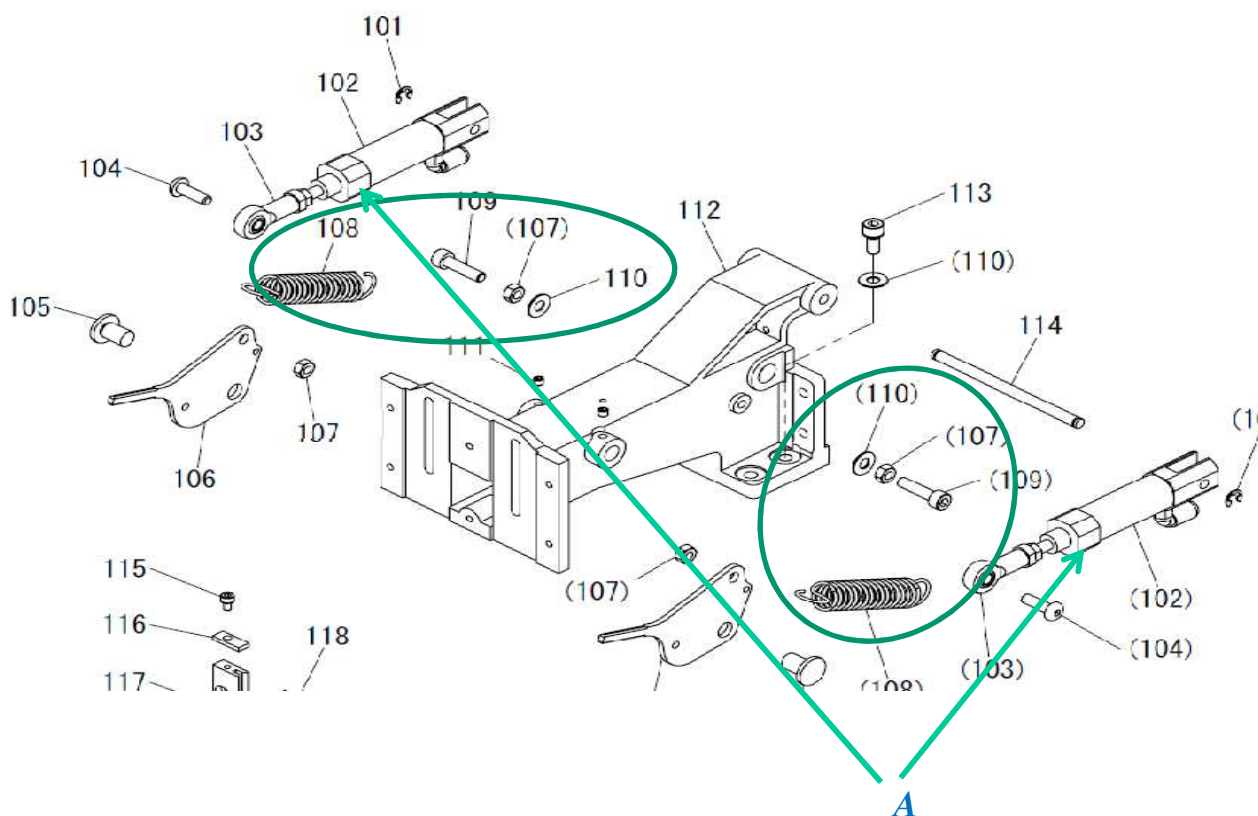

- *Démonter les bouchons A et les remplacer par les connecteurs pneumatique diamètre 4 fournit.*
- *Démonter les pièces 107,108,109,110.*

BRANCHEMENTS ELECTRIQUES ET PNEUMATIQUES

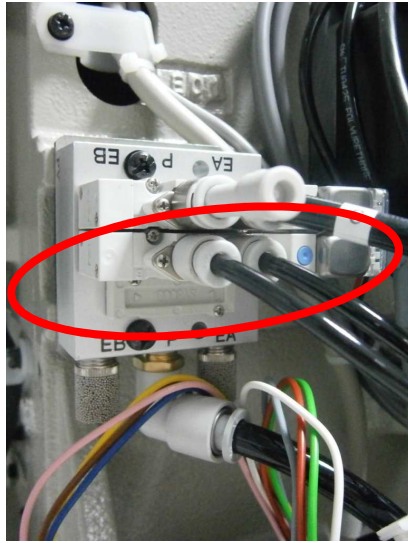

- Rajouter l'électrovanne sur le socle fixé sur le coté gauche de la machine, sous le carter.
- Connecter indépendamment la pince gauche et droite.
- Connecter l'électrovanne sur OP2 (Con 14) dans le PLK-G2-SOL. Le CON 14 correspond à la sortie O7

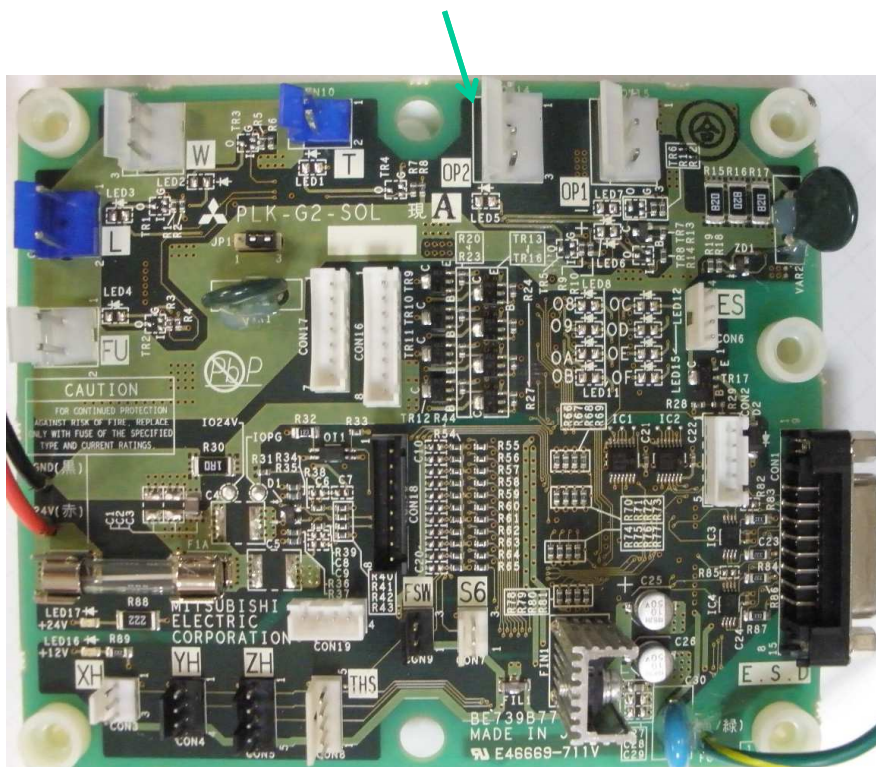

PARAMETRAGE MACHINE

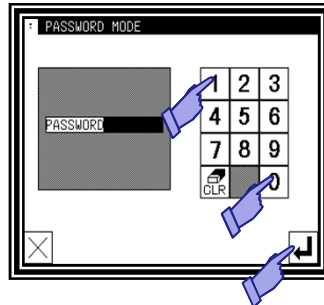
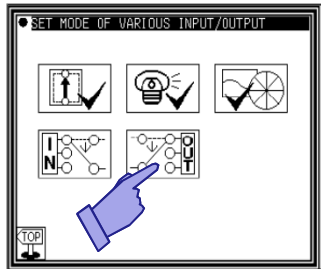
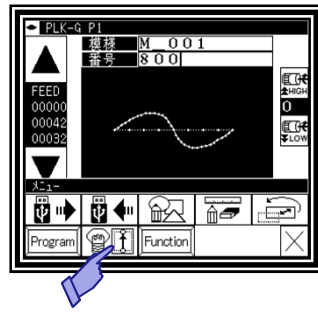
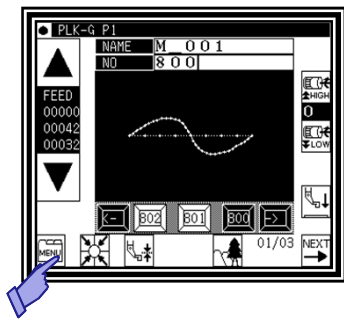

1010

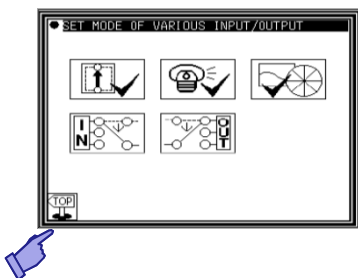
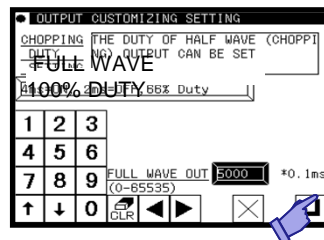
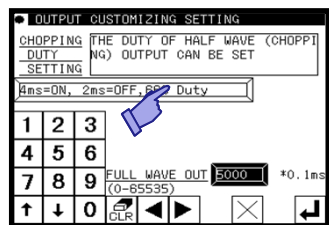
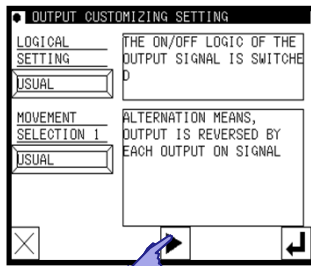
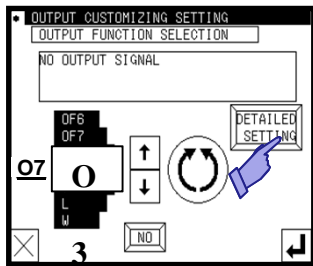
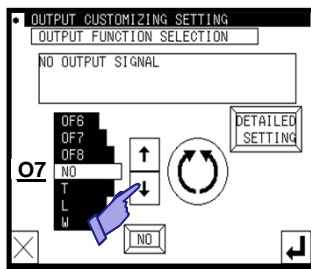
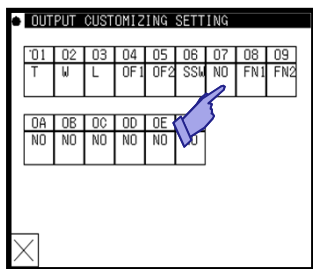

PARAMETRAGE des PINCES

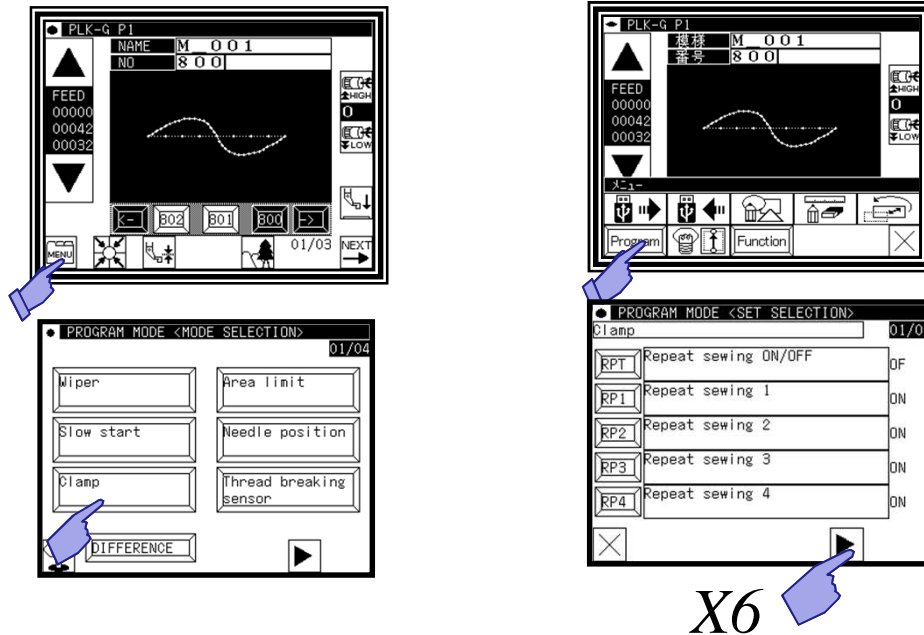

X6

Il faut modifier le nombre de pince utilisées FN = 3

IMPLANTATION

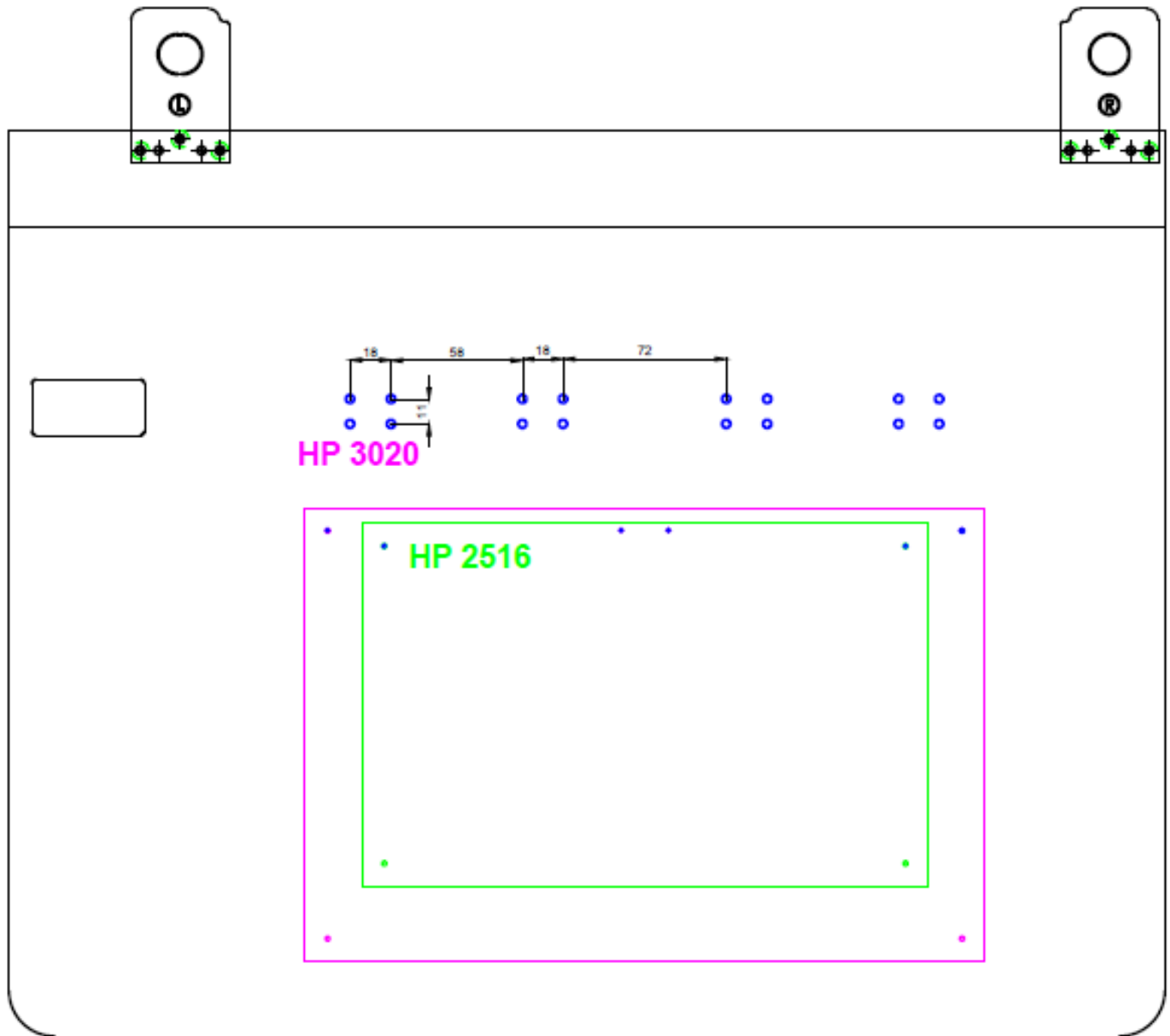



29 Bd des Bouvets 92741 Nanterre Cedex
Tel 01 41 02 83 00 - Fax 01 49 01 07 28
www.ism.mitsubishielectric.fr